

# Model 25AM

VERTICAL PERSONNEL LIFTS



## MORE ECONOMIC

- No noise, no emissions and low weight mean you can simply push into position and start.

## MORE PRODUCTIVE

- Reach more easily with platform heights from 12.5 m to 16.2 m and capacities from 135 kg to 160 kg.

## MORE ACCESS

- Work anywhere with battery or AC power options built in.

## SMART DESIGN

- Hardly any set-up time required.



## Standard Features

- 0.66 m x 0.66 m (W x L) Slide bar side entry platform
- Quick-change platform mounts
- Safety interlocked controls
- Load sensing system
- Lanyard attach points
- AC power cable to platform
- 6 wheel chassis with 'X' pattern outriggers
- Outrigger interlocks with LED indicators
- Non mark tyres and casters
- Roller loading device
- Battery condition indicator<sup>2</sup>
- Detachable battery & charger compartment<sup>2</sup>
- 12V 100 A/hr deep cycle battery operation (DC models)
- Low maintenance anodised aluminium mast
- Spring loaded sequence cables
- Manual descent
- Key lock main power switch
- Hour meter
- Transportation tie-down lugs
- Fork truck pockets

## Accessories & Options

- 0.56 m x 0.64 m Narrow Slide Bar Entry Platform
- Choice of 110V or 230V operation
- Sealed 12V 100A/hr maintenance free AGM battery<sup>1</sup>
- 20 amp automatic battery charger<sup>2</sup>
- Straddle extension kit with 1.09 m clearance
- Straddle extension kit with 1.40 m clearance
- Programmable 4 digit security lock
- Lifting eye for crane hook
- Fluorescent tube caddy
- Tool Tray
- Descent alarm
- Emergency lowering control
- Amber strobe light
- Straddle Outrigger Interlock Adapter
- Synthetic Biodegradable Hydraulic Oil
- Euro Plug & Socket
- Special paint colour

<sup>1</sup> Includes 5 hour battery charger

<sup>2</sup> Applicable to battery powered DC models only

# Model 25AM

## VERTICAL PERSONNEL LIFTS

### Performance

• Working Height	9.67 m
• Platform Capacity	160 kg
• Platform Size – Narrow (W x L)	0.56 m x 0.63 m
• Platform Size – Side Entry (W x L)	0.66 m x 0.66 m
• Base Width – Stowed	0.74 m
A. Overall Height – Stowed	1.97 m
B. Base Length	
Stowed	1.24 m
Without Platform	1.19 m
C. Ground Entry Height	0.48 m
D. Outrigger Footprint Size	1.73 m x 1.57 m
• Distance to Wall – Front	0.20 m
• Distance to Wall – Side	0.44 m
• Machine weight – AC *	365 kg
• Machine weight – DC *	395 kg
• Rear Wheel Diameter	25 cm
• Caster Wheel Diameter	15 cm

\* Certain options or country standards may increase weight and/or dimensions.



### Reach Diagram

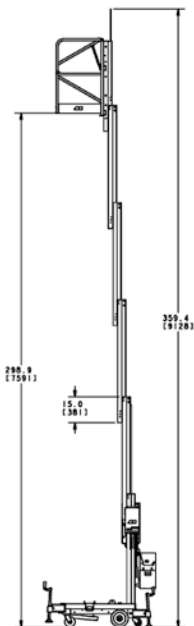

### Dimensions

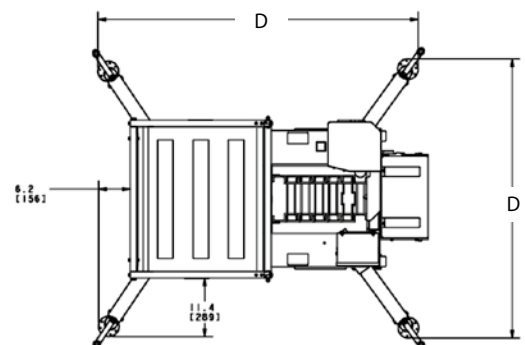
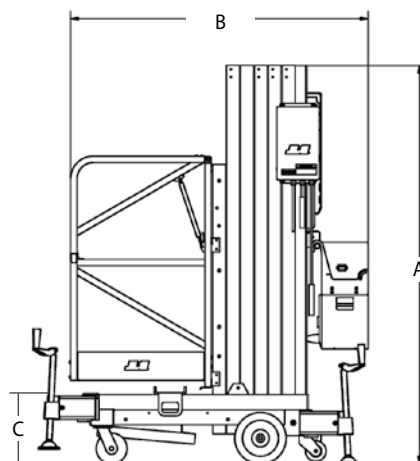

### IMPORTANT

JLG is continually researching and developing products and reserves the right to make modifications without prior notice. All data in this document is indicative. Certain options or country standards will increase weight. Specifications may change to meet country standards or with the addition of optional equipment.

Due to continuous product improvements, JLG Industries reserves the right to make specification and/or equipment changes without prior notification.



### JLG EMEA BV

Polaris Avenue 63  
2132 JH Hoofddorp  
The Netherlands  
Tel: +31 (0)23 565 5665  
Fax: +31 (0)23 557 3750  
[www.jlg.com](http://www.jlg.com)

An Oshkosh Corporation Company