

LED-4 SERIES II

LIGHTING TOWER



Performance

Height Stowed	2.50 m
Length Stowed	
Towbar in Transport Position	2.38 m
Towbar in Towing Position	3.13 m
Stowed Width	1.75 m
Weight GVM	1485 kg
Length with Outriggers Extended	3.75 m
Width with Outriggers Extended	3.15 m
Mast Max. Elevation	8.12 m
Wind Speed Rating	100 km/hr

Standard Specifications

Power

Engine	Kubota Z482-E4B
Engine Emission Level	Tier 4 Final
Fuel Type	Diesel
Fuel Consumption (litre per hour)	0.95 L/hr
Running Time (hours)	380+ hours
Generator	Mecc Alte PM5G 48V DC
Lights	LED
Light Power	4 x 500 W
Luminous Output	248,000 lm
Control System	Electronic Control
Noise Level @ 7m radius	65 dB(A)
Fuel Tank Capacity	370 L

Travel

Wheels	16" x 6J
Tyres	205/80 x 16"
Towing Speed (maximum)	80 km/ hr

Mast System

Lift	Hydraulic
Mast Lift Time	90 seconds
Mast Lower Time	75 seconds
Telescope	Hydraulic
Lighthouse Tilt	115° Hydraulic
Rotate	350° Manual
Hydraulic System Pump	
Voltage	12V DC
Pressure	192.5 bar (2800psi)
Flow Rate	0.78 cm ³ /rev
Function Control	Electric over Hydraulic



Standard Features

- External Emergency Stop
- Bunding for all Fluids (110%)
- Auto Stop / Start
- Forklift Tyne Pockets
- Crane Lifting Points
- Extendable Drawbar with transport stabiliser
- Long Extension Wind Down Outriggers
- 350° Rotation of Light Head
- Torsion Independent IRS Axle
- Drum Brakes with Hydraulic Over-ride
- 12 / 24 V LED Trailer Traffic Lights
- 7 Pin Flat Trailer Plug
- Inside canopy work light
- Low fuel cut-out

Options

- Fire extinguisher 4.5kg
- Double pole battery isolator
- Starter motor isolator
- Anderson jump start receptacle
- Wheel chocks
- Beacon
- Reflective tape
- Pressure relief radiator cap
- Hydraulic outriggers
- Customised paint
- Alternative trailer plugs
- Exhaust heat wrap
- MDG-15 Spec

LED-4 SERIES II

LIGHTING TOWER



Dimensions

All dimensions are approximate.

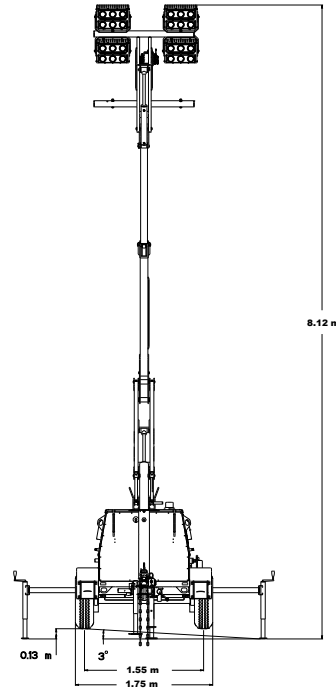
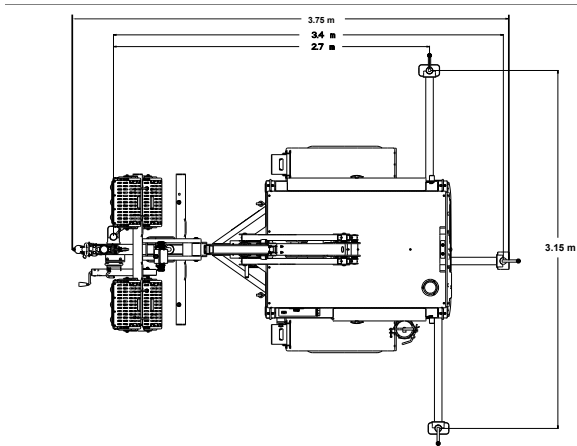

Isolux Plot

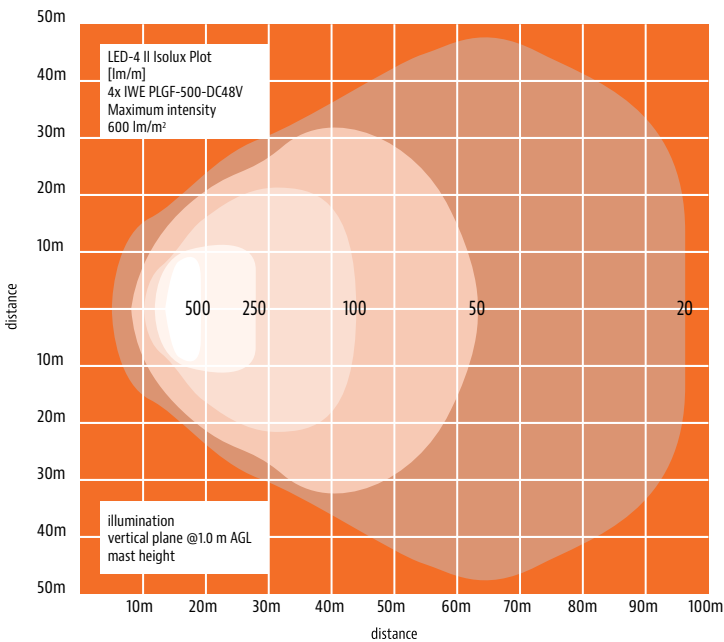

The JLG "1 & 5" Warranty

JLG Industries, Inc. backs its products with its exclusive "1 & 5" Warranty. We provide coverage on all products for one (1) full year and cover all specified major structural components for five (5) years. Due to continuous product improvements, we reserve the right to make specification and/or equipment changes without prior notification.

Part No.: 111319
R010820

JLG Industries (Australia)

358 Park Road
Regents Park, NSW 2143
Telephone 02 8718 6300
Fax 02 8718 6377

www.jlg.com.au

An Oshkosh Corporation Company